

Année du jardin 2016 à Lausanne

Colloque: « Quels jardins pour la ville d'aujourd'hui ? »

espaces publics,
dispositions pour des vécus à venir
(préparer le terrain)

7 octobre 2016

Marco Rampini, Atelier Descombes Rampini , Genève

008
Türbinenplatz
Zurich, Suisse, 2003

Aménagement d'une place au cœur de l'ancien site industriel de Sulzer-Escher Wyss

Maitre d'ouvrage : Sulzer Immobilien, Winterthur

Concours sur invitation : 2000, 1^e prix

Projet : 2000-2001

Réalisation : 2002-2003

En collaboration avec :

Tobias Eugster, architecte, Zurich

Les Eclairagistes Associés, Lyon

Ingénieur civil : Flückiger + Bosshard, Zurich

Ingénieur civil : Passera & M. Pedretti, Zurich

Ingénieur électricité : Suisselectra Ing., Bâle

Nomination au "Auszeichnung für gute Bauten der Stadt Zürich 2002-2005"

Distinction "Die Besten 2004", catégorie paysage (prix Hochparterre)





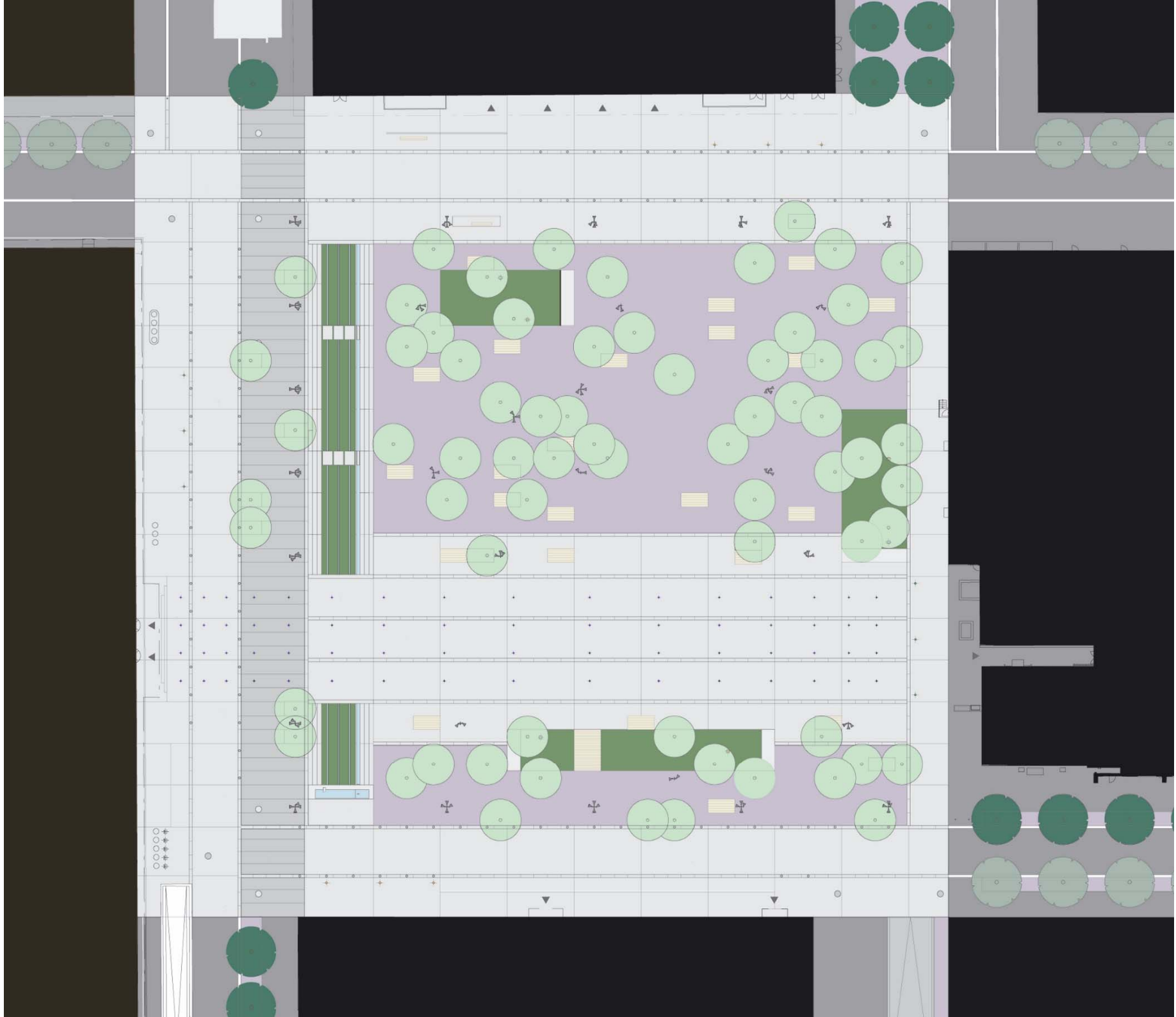

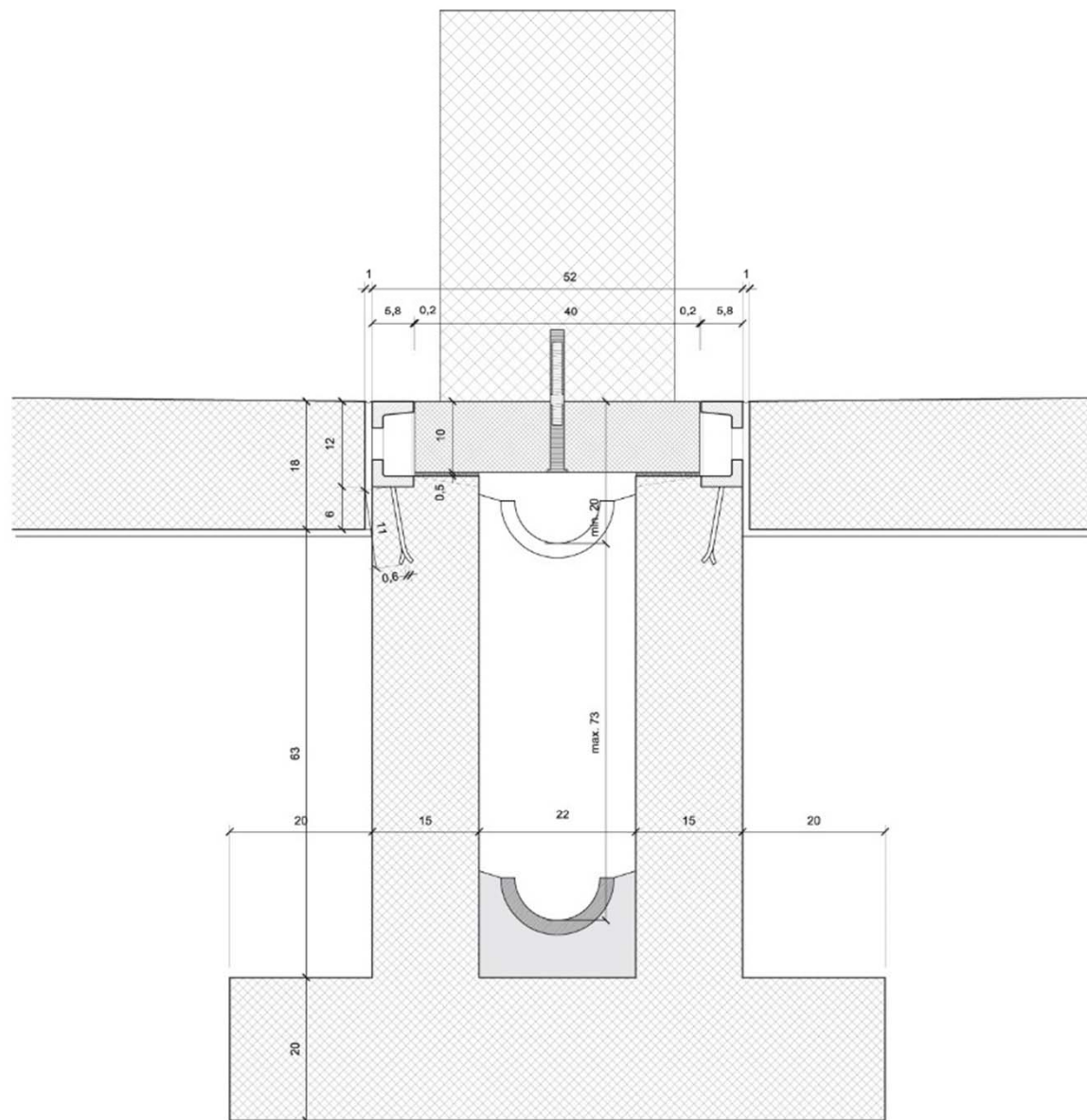

COUPE SUR CANIVEAU ET BORNE
 1:5



















035

Place Simon-Goulart, Genève, Suisse, 2013

Aménagement d'une nouvelle place de quartier
au centre-ville de Genève

Maître d'ouvrage : Ville de Genève

Concours sur présélection : 2003, 1^e prix

Projet : 2003-2010

Réalisation : 2008-2013

En collaboration avec :

B. Ott & C. Uldry, ingénieur civil, Thônex

Les Eclairagistes Associés, Lyon

Géomètre : Christian Haller, Genève

Distinction du Flâneur d'or 2014 (prix Mobilité
piétonne Suisse)













LE ST-GERVAIS
GENEVE
THEATRE

le mieux! Jean Vilar



169

Quartier du Flon, Lausanne, Suisse, 2015

Projet d'aménagement des espaces publics et
de l'esplanade centrale de l'ancien du
quartier industriel du Flon

Maître d'ouvrage : Mobimo SA, Lausanne

Concours sur invitation : 2015, 1^e prix

Projet : 2015-2016

Réalisation : à venir

En collaboration avec :

Les Eclairagistes Associés, Lyon

Ingénieur civil : Perret-Gentil & Rey, Lausanne

Ingénieur électricité: Betelec, Lausanne

Ingénieur san.: Groupe technique H2, Lausanne



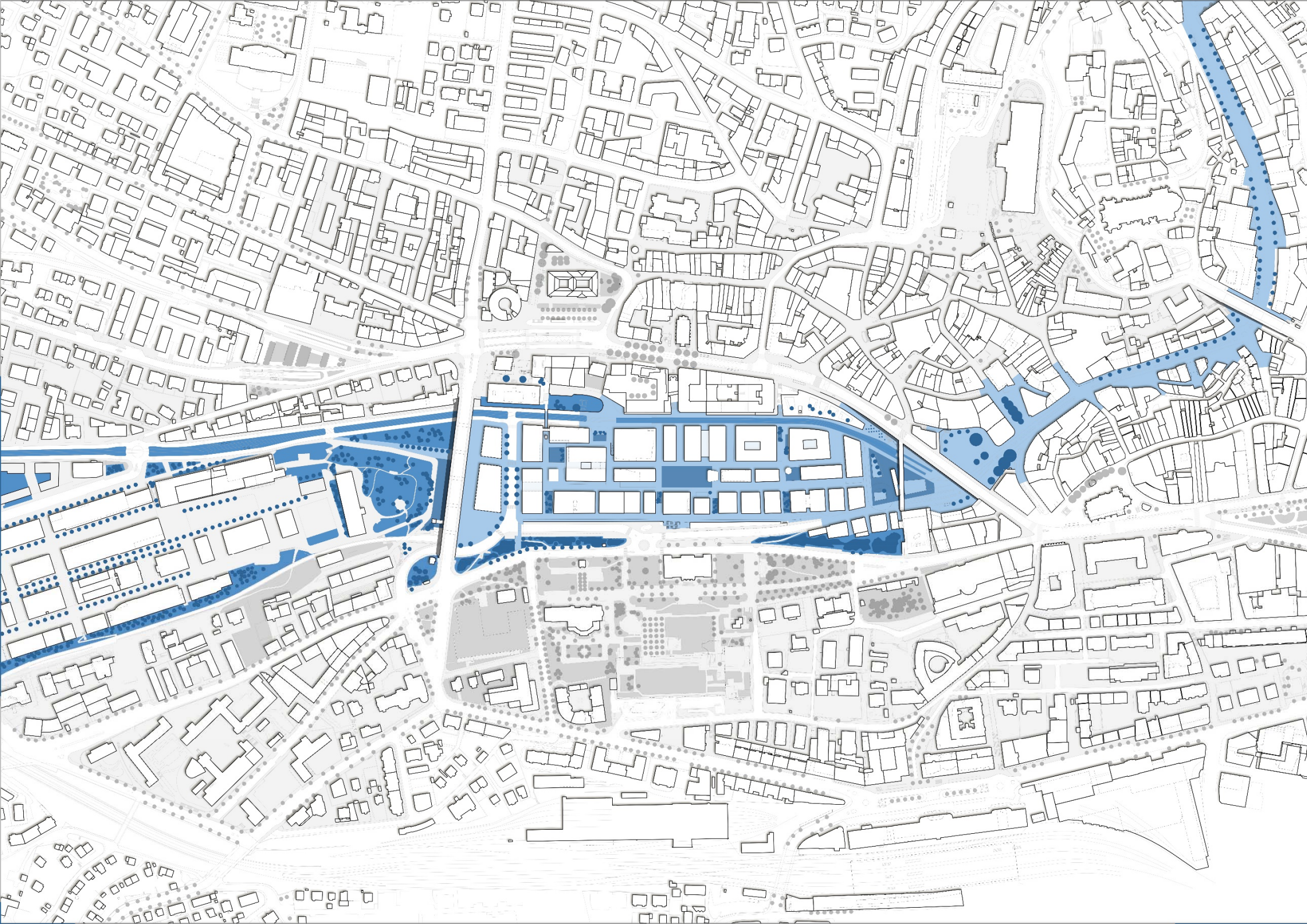

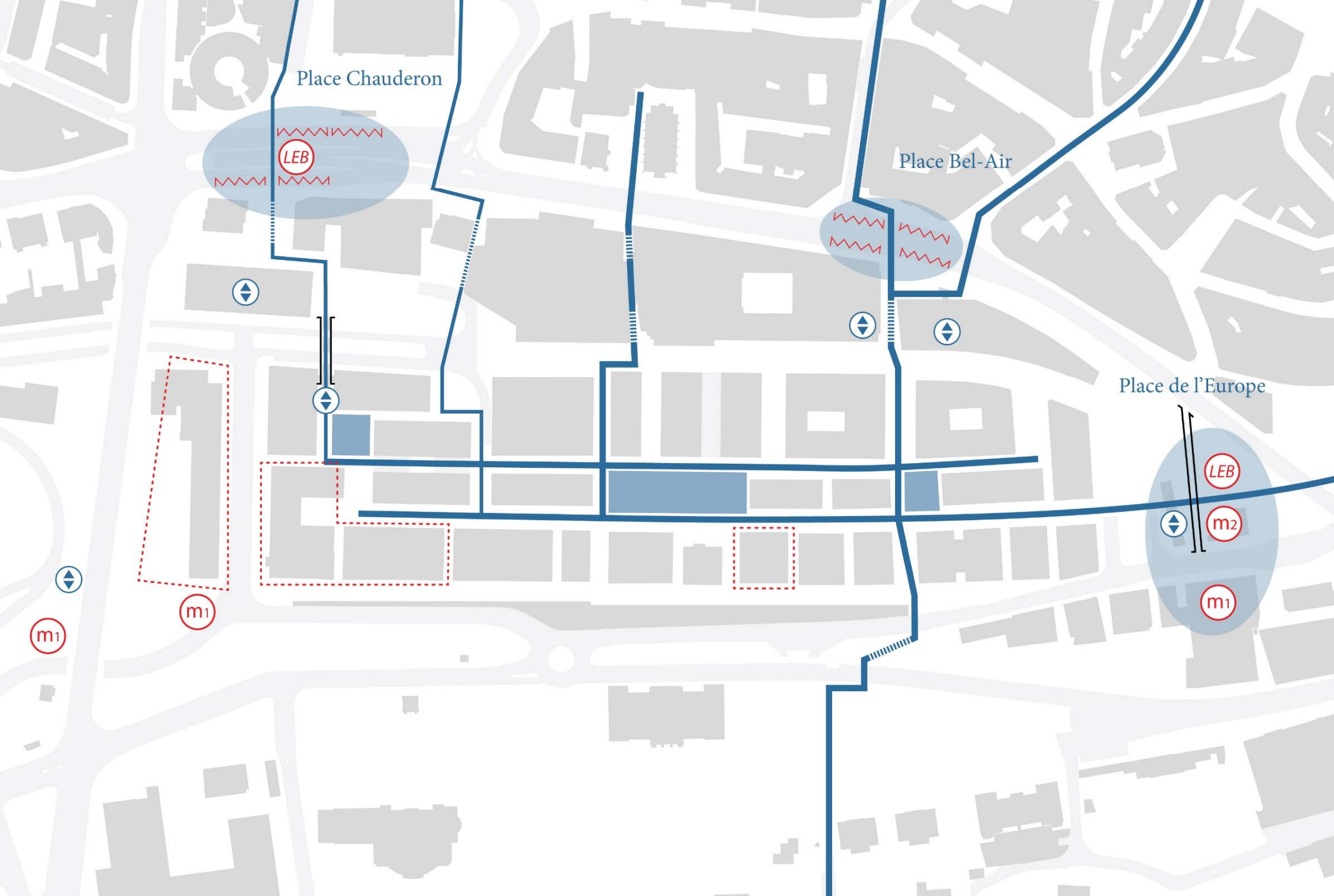

Place Chauderon

Place Bel-Air

Place de l'Europe

LEB

LEB

m2

m1

m1

m1

Principaux axes piétons

Places et placettes

Pôles de transports publics

Secteurs en mutation

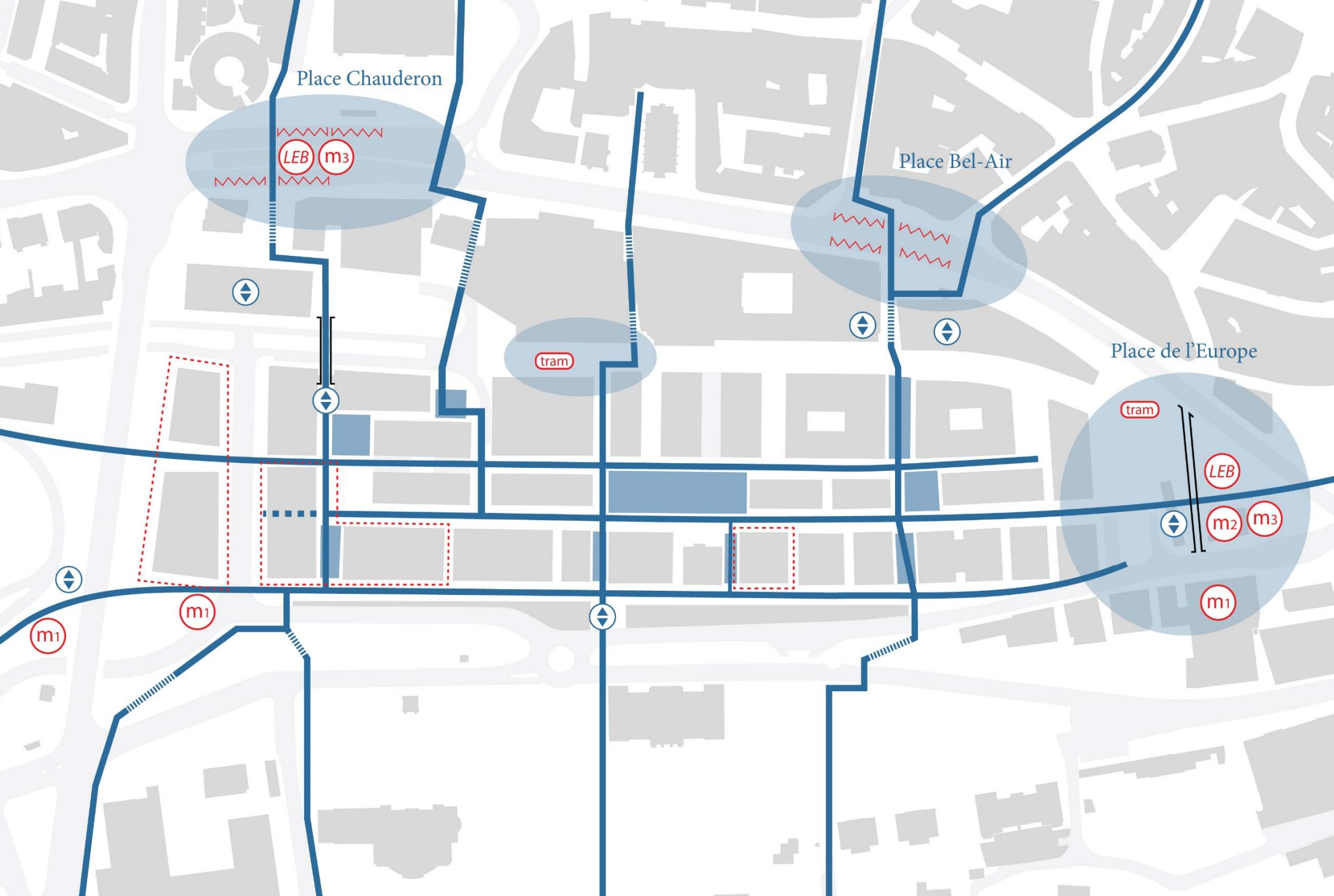

— Principaux axes piétons

■ Places et placettes

● Pôles de transports publics

⋯ Secteurs en mutation











014

Cours d'eau de l'Aire, Genève, Suisse, 2006-15

Revitalisation d'un cours d'eau canalisé aux XIXe et XXe siècles, construction d'ouvrages de protection contre les crues et aménagement de la promenade et des jardins de l'Aire

Maître d'ouvrage : Etat de Genève

Concours sur présélection : 2001, 1e prix

Projet : 2002-2011

Réalisation : 2006, 2008-2010, 2012-2015

En collaboration avec :

Georges Descombes, architecte, Genève

B+C ingénieurs, Onex

ZS ingénieurs civils, Onex

Biotec biologie appliquée, Delémont

Distinction "Die Besten 2009", catégorie paysage (prix Hochparterre)

Prix Schulthess des jardins 2012 (prix Patrimoine suisse)

Hase in Gold "Die Besten 2015", catégorie paysage (prix Hochparterre)

Distinction SIA Genève 2016 (Prix de la Société suisse des ingénieurs et des architectes)

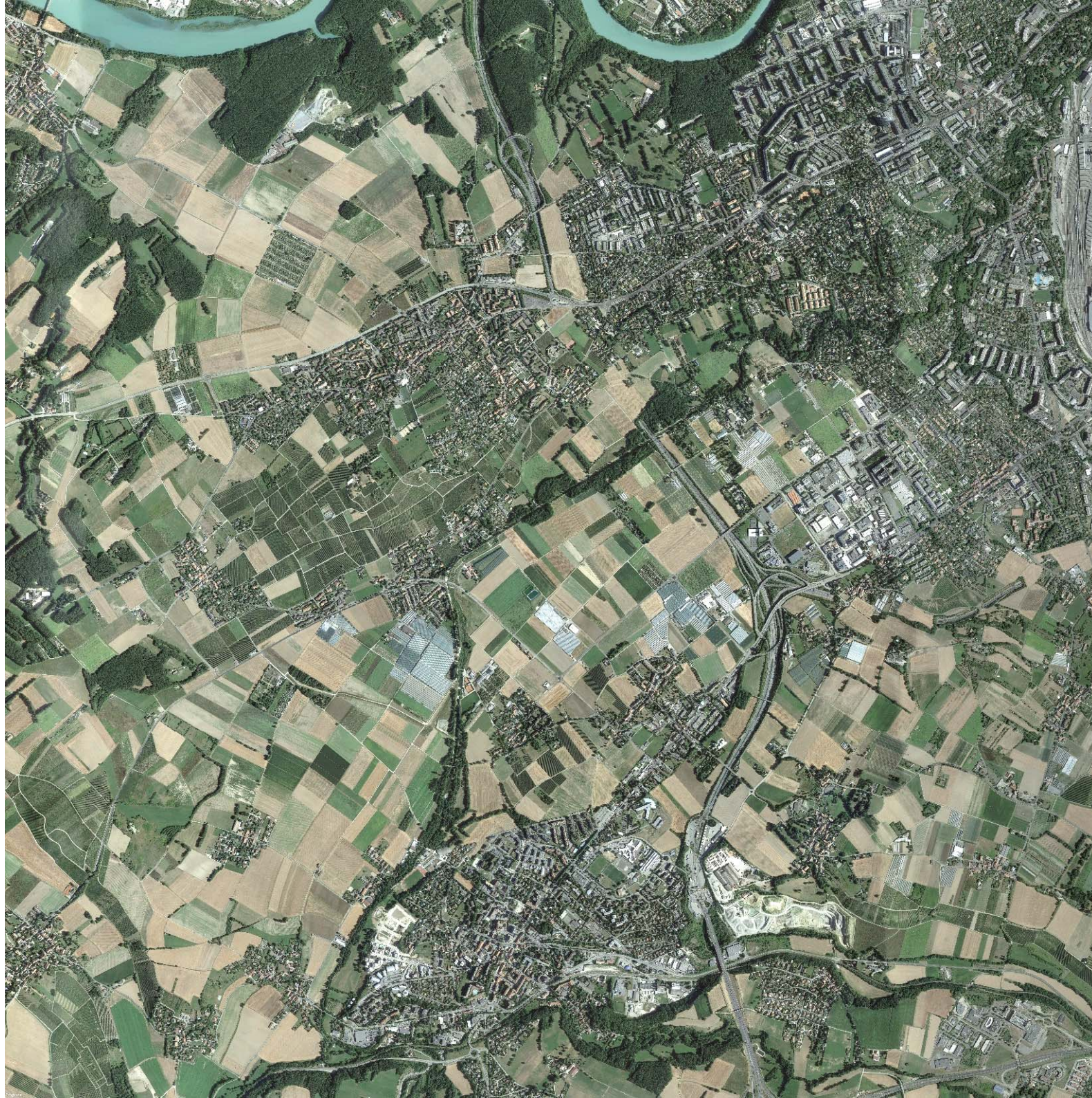



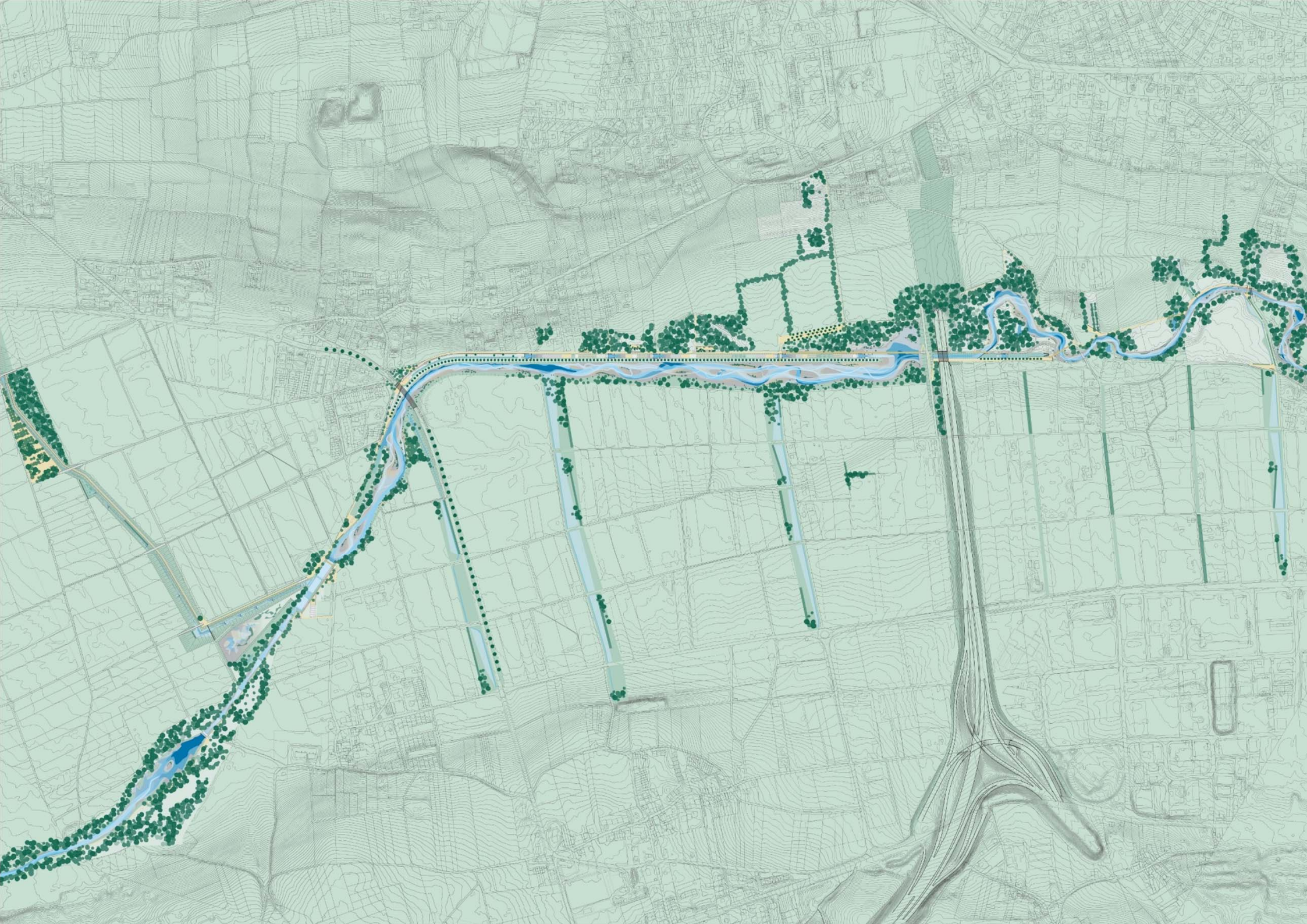













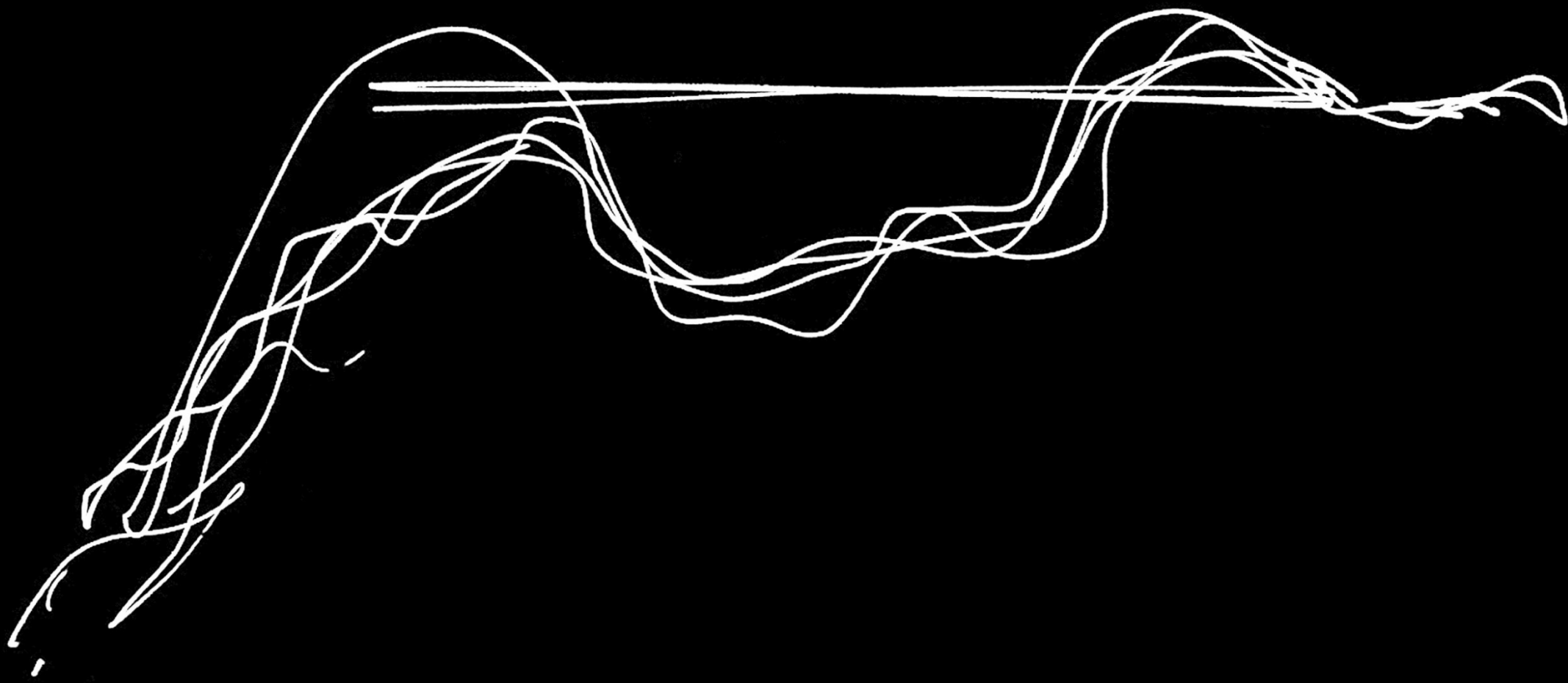

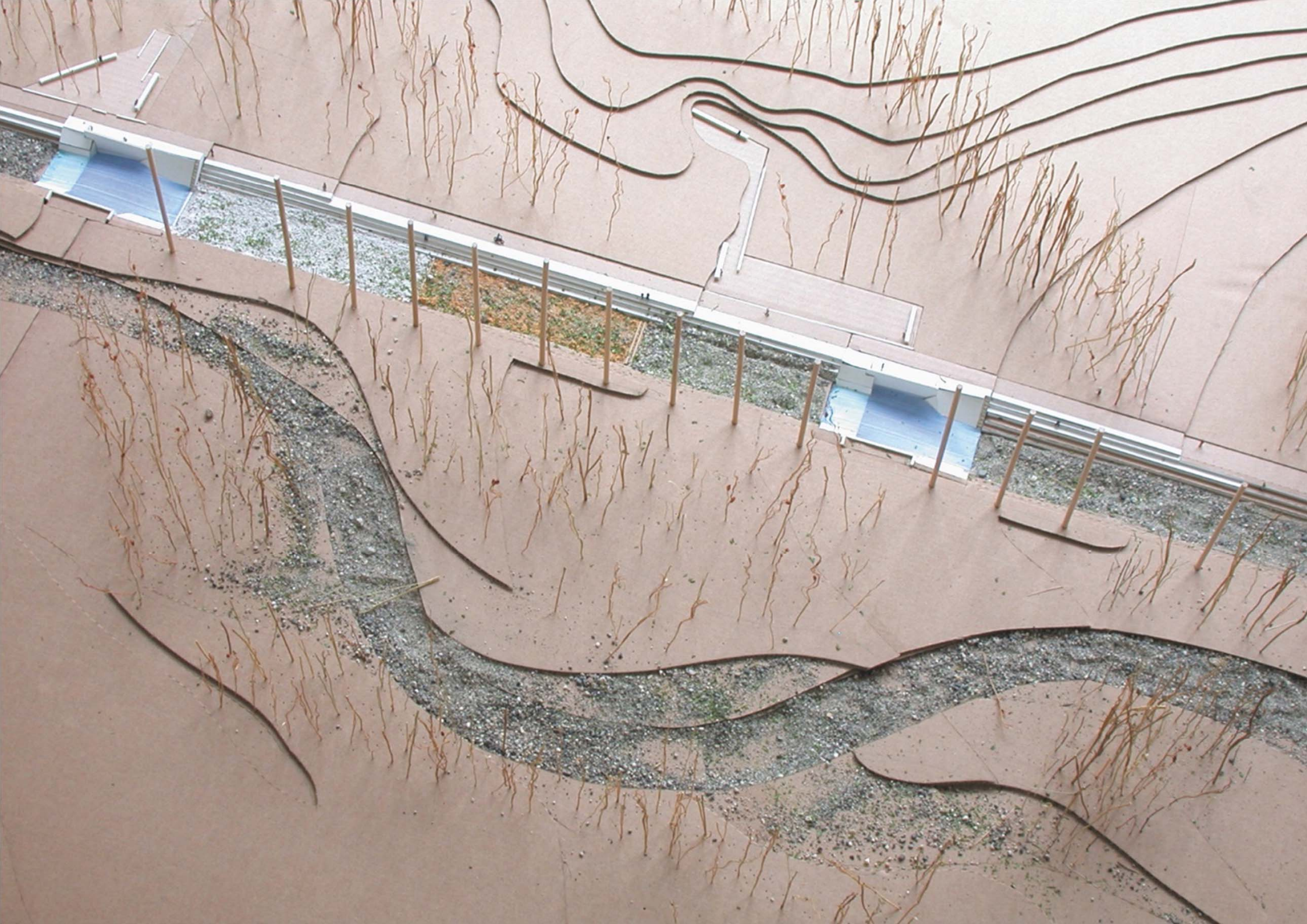













































GARE CORNAVAIN

GARE EV

VOIE VERTE

GARE CHENE-BOURG

GARE CHAMPEL

TRAM

GARE POINT ROUGE

L'AIRE

LE VOIRET

GARE BACHET

LA DRIZE

LA SEYMAZ

LE FORON

ATLAS TOPOGRAPHIQUE
DE LA SUISSE

CANTON DE GENÈVE

Echelle 1 : 25 000

4^{me} Edition

Les hauteurs ont été dessinées d'après la Carte de France

LÉGENDE

- QUARTIERS URBAINS
- CONSTRUCTIONS CONTIGUES (VILLAGES)
- COLONIES ET BÂTIMENTS ISOLÉS
- CHEMINS DE FER INDUSTRIELS
- CULTURES, CONSTRUCTIONS AGRICOLES
- SURFACES PUBLIQUES OU SITES A CLASSER
- BOIS ET PARCS A CONSERVER

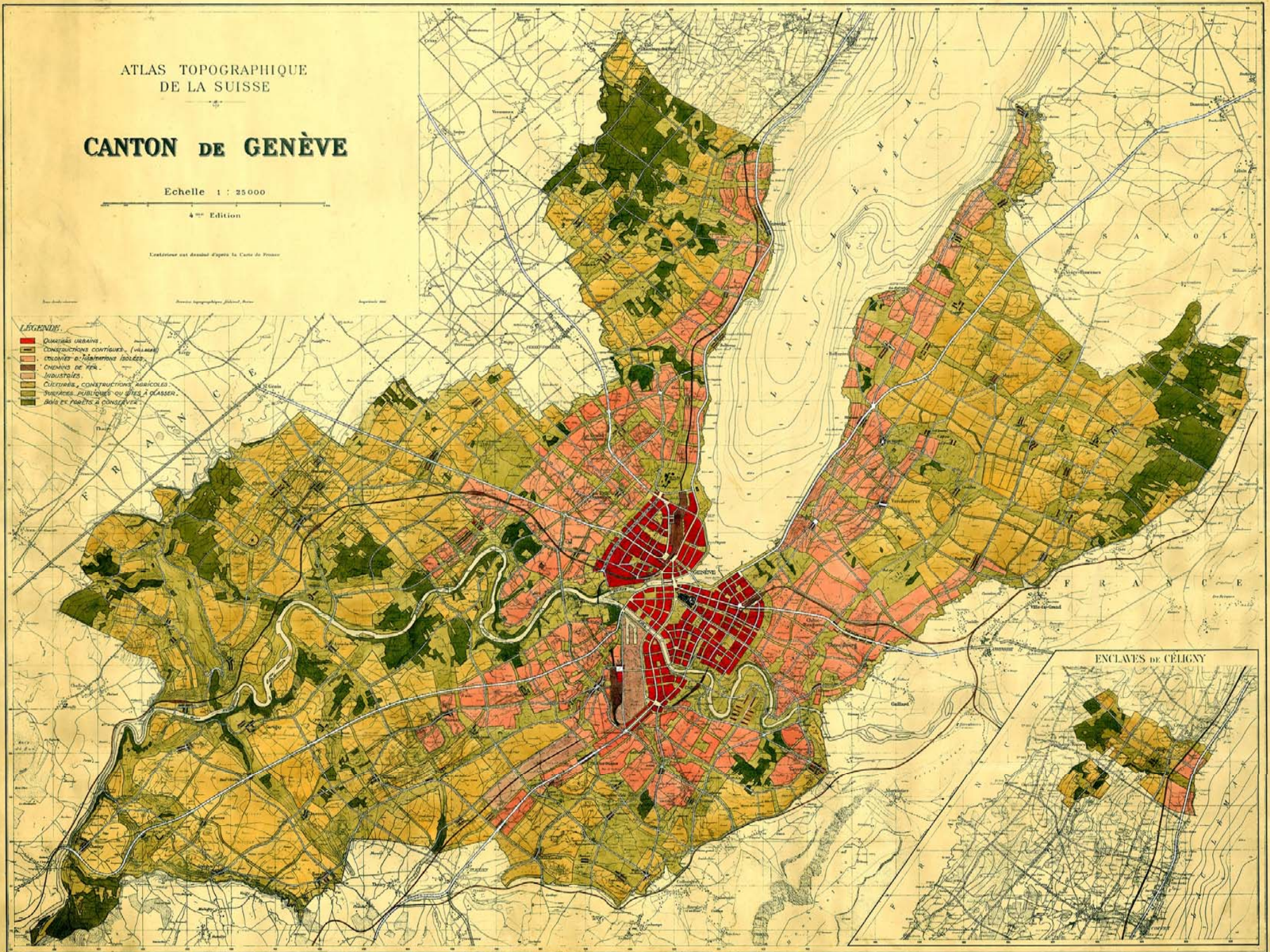

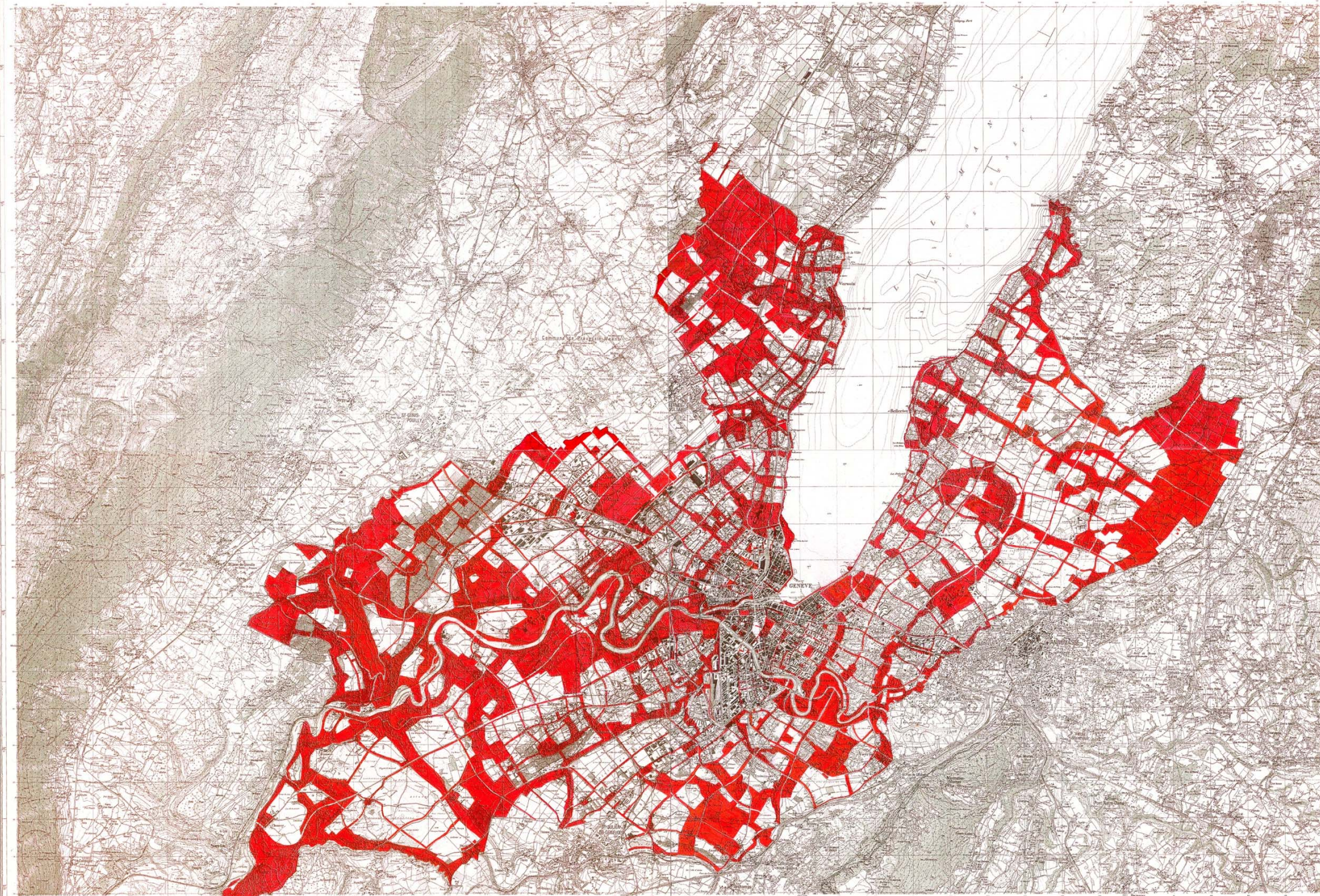

072

Plage des Eaux-Vives, Genève, Suisse

Aménagement d'une nouvelle plage publique
et d'un port dans la Rade de Genève

Maître d'ouvrage : Etat de Genève

Projet : 2009-en cours
Réalisation : 2017-2019

En collaboration avec :
edms, ingénieur civil, Lancy
LLJ, architecte, Genève

Géotechnicien : Karakas & Français, Lancy
Géomètre : Adrien Küpfer, Genève
Ingénieur environnement : Viridis, Lancy
Ingénieur gestion des matériaux : Ecoservices,
Carouge
Ingénieur chauffage et ventilation : JDR
énergie, Confignon
Ingénieur sanitaire : Frédy Margairaz, Genève
Ingénieur électricité : Zanetti, Lancy
Ingénieur mobilité : Citec, Genève









